

**O3 Hydro 10 / 20**

# **USER MANUAL**

## TABLE OF CONTENT

1. Safety Precautions	1
2. Device Identification	3
3. System Overview	7
4. Control Panel Identification	8
5. Fault Indicator	9
6. Getting Started	14
7. Installation Of Device	20

## **SAFETY PRECAUTIONS**

### **⚠️ WARNINGS - *To reduce the risk of electrical shock, fire or injury:***

1. Do not use the device if the power cable or plug is damaged.
2. Do not insert any sharp or pointed object through the ventilation holes of the device.
3. Do not let unauthorized personnel to play with the device.
4. Do not immerse the device in water, or allow water or any fluids to enter through the ventilation holes.
5. When removing the power plug, always hold the plug and never pull the cable.
6. Do not remove the power plug when your hands are wet.
7. Remove the power plug from the wall socket before cleaning the device.
8. Do not modify, disassemble or repair this device without proper training unless stated in the manual.
9. Do not replace the electric plug or cut the power cable. Replacing the plug or cutting the power cable in any way will immediately cause the Warranty to become void. Any subsequent fault in the operation of the device will not be covered by the Warranty, and repair and servicing will be chargeable.
10. If the power cable is damaged, contact an authorized Medklinn Service Centre for repairs immediately.
11. Do not attempt to open the inner compartment of the device. The device requires minimal maintenance, and no servicing or repairs are to be carried out by the User. Opening the device or tampering with it in any way will cause the Warranty to become void. If you encounter any problems with the device, please contact the nearest authorized Medklinn Service Centre.
12. Do not wipe the device with benzene or paint thinner.

**FOR FURTHER ASSISTANCE, PLEASE CALL OUR CUSTOMER SERVICE.**

**NOTE – Radio, TV or sensitive equipment interference:**

If the device should cause interference to radio, television reception or any sensitive equipment, try to correct the interference by one or more of the following measures:

- Reorient or relocate the receiving antenna.
- Increase the distance between the device and radio/TV receiver/sensitive equipment.
- Connect the device into an outlet on a circuit different from that to which the receiver is connected.
- Consult the dealer or an experienced radio/TV technician for help.

**Cautions during operation:**

1. Place the device at least 6 feet from radio, television or electronic equipment. This is to minimize the possibility of interference with the equipment or the remote controller.
2. Do not cover the device in any way at all, particularly the ventilation holes. Doing so will cause excessive heat build-up and may result in a fire and irreparable damage to the device.
3. Avoid placing the device where curtains or other furnishings may cover the ventilation holes.
4. Avoid placing the device in an oily environment as it may cause the module to be coated with a thicker layer of grease/debris. Hence, affecting its performance.
5. Ensure that there is free flow of air around the device.
6. Avoid locations where the device is exposed to condensation due to rapid and drastic temperature fluctuations. The device should only be used in temperatures between 5°-35°C.

## Device Identification

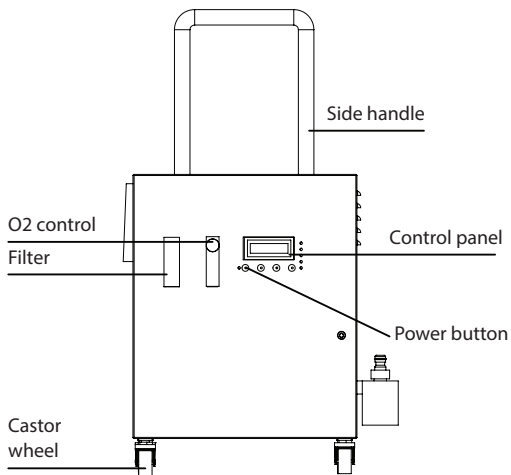

Medklinn O3 Hydro 10 /20 (Front View)

## Functional parts

<b>Filter</b>	Filters the air supply
<b>O2 control</b>	Controls the amount of oxygen flowing into the device's ozone module
<b>Power button</b>	To switch the device ON/OFF
<b>Control panel</b>	Control/Monitors the entire system
<b>Castor wheel</b>	To ease in moving the device and allow the device to be stationary (lockable)
<b>Door</b>	Door of the device
<b>Door Lock</b>	Lock the device's door

## Device Identification

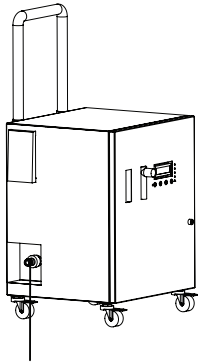

Water outlet

Medklinn O3 Hydro 10 /20 (Left Side View)

### Functional parts

<b>Water outlet</b>	Ozone water flows out from here
---------------------	---------------------------------

## Device Identification

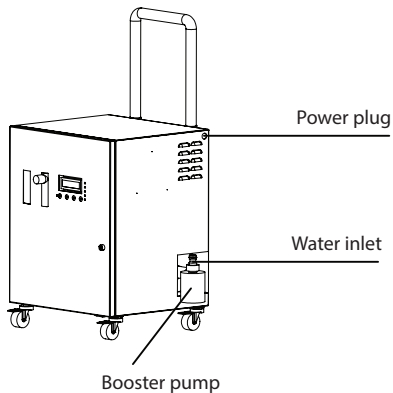

Medklinn O3 Hydro 10 /20 (Right Side View)

### Functional parts

<b>Power plug</b>	The power rating of the power plug is 220/240v
<b>Water inlet</b>	Water source flows in through here
<b>Booster pump (Optional)</b>	To boost the flow of the water source

## Device Identification

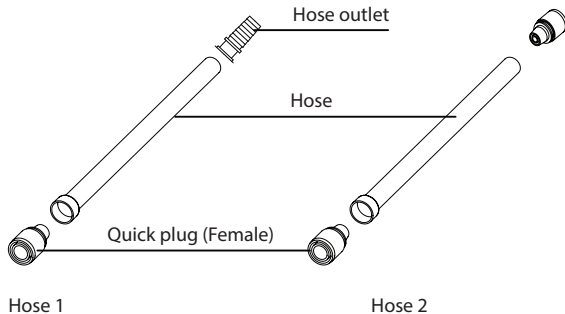

Medklinn O3 Hydro 10 /20 Accessories

### Functional parts

<b>Quick plug (Female)</b>	Secures the hose to the water source and device
<b>Hose outlet:</b>	Focuses the spray pattern of the water



## System Overview

Medklinn O3 Hydro 10 / Hydro 20 converts supplied oxygen (O<sub>2</sub>) into ozone (O<sub>3</sub>) and infuses it into the water. The ozone water

- Disinfects and deodorizes surfaces without hot water
- Eliminates bacteria viruses and mould
- Removes and prevents biofilm build-up
- Dissolves oil and grease

When the Medklinn O3 Hydro 10 / Hydro 20 operates, the air is drawn into the device through the HEPA filter. This air is forced through a fine mesh filter that traps pollutants before passing into the oxygen tank, which separates the nitrogen from the air, resulting only oxygen is passed through. The concentrated oxygen is finally supplied to the ozone module which breaks it down to ozone (O<sub>3</sub>) with the use of electricity. It is then infused into the water through venturi injection to generate ozone water.

## Control Panel Identification

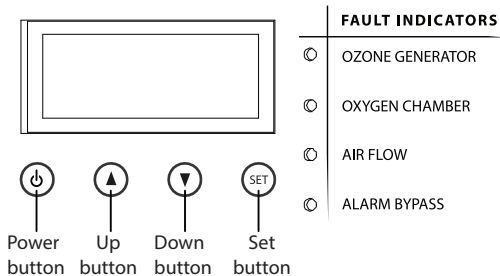

<b>Display screen:</b>	Displays information status of the device
<b>Power button:</b>	To turn on the device
<b>Up / down button:</b>	To scroll up and down in the menus
<b>Set button:</b>	To select options in the menus

## Fault Indicators

<b>Ozone generator:</b>	Points to a problem with the ozone generator
<b>Oxygen chamber:</b>	Points to a problem with the oxygen chamber
<b>Air flow:</b>	Points to a problem with the air flow
<b>Alarm bypass:</b>	Shows that an alarm bypass was done and the device will continue running for another 30 days before shutting down

NOTE: Follow the instruction displayed on the screen if any address fault occurred

## Fault Indicators on the Control Panel

Fault indicators appear to notify the user that there is a problem with the device. It is also accompanied with a buzzer sound. It directs the user to which component has failed.

### Ozone Generator Fault

Condition: Buzzer sound emitted, red light on Ozone Generator, Display Screen shows ALARM: O3, Press v (Down) to mute.

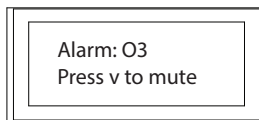

#### FAULT INDICATORS

- OZONE GENERATOR
- OXYGEN CHAMBER
- AIR FLOW
- ALARM BYPASS

#### Steps to take:

1. Press Down to switch off the alarm.

2. Contact the nearest Medklinn service centre to arrange for maintenance service immediately.

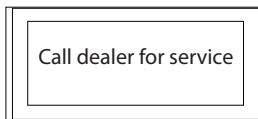

#### **FAULT INDICATORS**

- OZONE GENERATOR
- OXYGEN CHAMBER
- AIR FLOW
- ALARM BYPASS

3. Meanwhile, the device will still continue to operate for the time stated on the Display Screen.

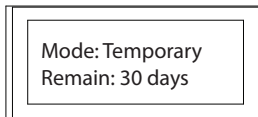

#### **FAULT INDICATORS**

- OZONE GENERATOR
- OXYGEN CHAMBER
- AIR FLOW
- ALARM BYPASS

### Oxygen Chamber Fault

Condition: Buzzer sound emitted, red light on Oxygen Chamber, Display Screen shows ALARM: O2, Press v (Down) to mute.

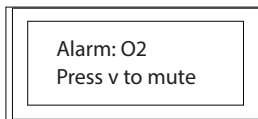

#### FAULT INDICATORS

- OZONE GENERATOR
- OXYGEN CHAMBER
- AIR FLOW
- ALARM BYPASS

#### Steps to take:

1. Press Down to switch off the alarm.
2. Contact the nearest Medklinn service centre to arrange for maintenance service immediately.

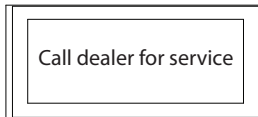

#### FAULT INDICATORS

- OZONE GENERATOR
- OXYGEN CHAMBER
- AIR FLOW
- ALARM BYPASS

3. Meanwhile, the device will still continue to operate for the time stated on the Display Screen.

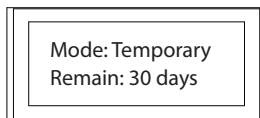

#### FAULT INDICATORS

- OZONE GENERATOR
- OXYGEN CHAMBER
- AIR FLOW
- ALARM BYPASS

#### Air Flow Fault

Condition: Buzzer sound emitted, red light on Air Flow, Display Screen shows Mode: Stopped, Call for service, device has stopped operating.

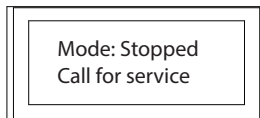

#### FAULT INDICATORS

- OZONE GENERATOR
- OXYGEN CHAMBER
- AIR FLOW
- ALARM BYPASS

**Steps to take:**

1. Check to see if the O2 Control knob is not fully closed.
2. If it is, turn the O2 Control knob up. Press Power twice to switch the device off and on again. After 40 seconds, check to see if the device operates back in normal mode (without the fault status above). The fault is resolved when the device is operating in normal mode after 40 seconds.
3. If it is not, press Power to switch the device off and contact the nearest Medklinn service centre to arrange for maintenance service immediately.

## Getting Started: Connecting the hose

### Using Quick Plug

1. Connect a Quick Plug (Male) to the water source pipe with male threaded end.

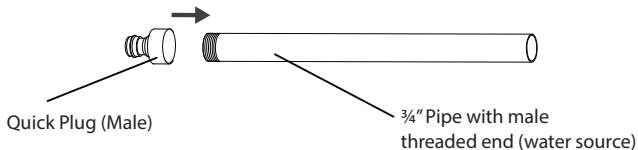

**NOTE: Make sure that there is enough Teflon tape when attaching the Quick Plug (Male) to the threaded end of the pipe to avoid leakage at that point**

2. Pull the yellow cap of the Quick Plug (Female) while connecting to the Quick Plug (Male). Release the cap to secure the connection. There should be a "click" sound when the Quick Plugs are secured together. Pull the hose gently to confirm that the connection is indeed secured.

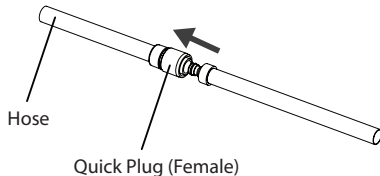



3. Connect the other quick plug (female) to the device's water inlet.

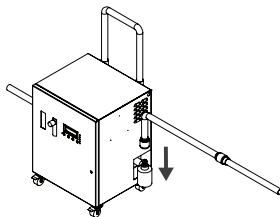

4. Connect the second hose's quick plug (female) to the device's Water Outlet.

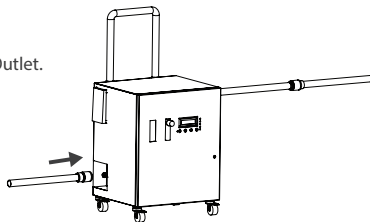

5. Switch on the device by pressing the power button.
6. Monitor the device status and oxygen flow by pressing up/ down button.

**NOTE: MODE:**

Mode: Standby

STANDBY – indicates that the device has no water flow

Mode: Normal

NORMAL – indicates that the device is functioning

Flow: 1 LPM

FLOW – shows the flow rate of the oxygen

**To a water tap**

1. If you have a water tap, please remove one end of the Hose 2 Quick Plug (Female) by loosening the cap.

Hose 1



2. Pull out the Quick Plug.

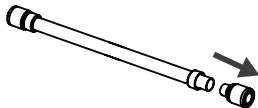

3. Connect the hose to the water tap. Insert the hose clip to the hose before connecting to the water tap. Tighten the connection by using the hose clip with a screwdriver. Ensure it is tight and water will not leak out when the tap is turned on.

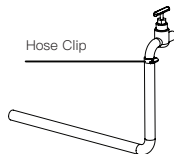

4. Connect the other Quick Plug (Female) to the device's Water Inlet.

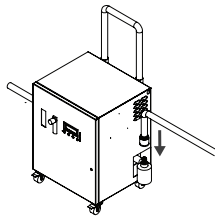

5. Connect the second hose's Quick Plug (Female) to the device's Water Outlet.

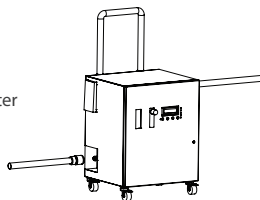

## Getting Started: Turn on the device

1. Plug the power inlet to the AC power outlet.
2. Connect both hoses provided to the device (Refer to Connecting the hose section).
3. Turn on the water supply.
4. Turn on the power button.
5. Make sure that the flow rate of the O2 Control is between 1- 1.5 lpm.

## Getting Started: Controlling the ozone level into the water

The Medklinn O3 Jetspray Hydro 10 / 20 ozone level is controlled by turning the knob of the O2 Control to increase or decrease the level ozone generation. It is advisable to keep the flow rate between 1 - 1.5 lpm.

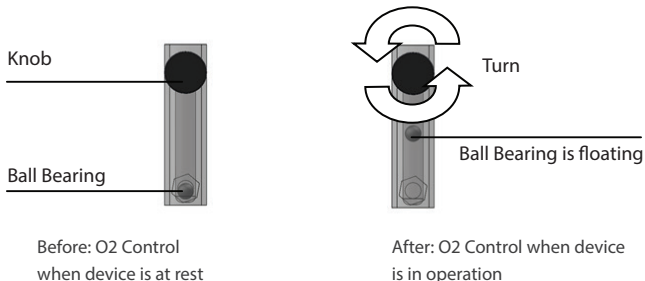

## Locking/unlocking the castor wheel

1. Make sure that the castor wheel is facing outward.

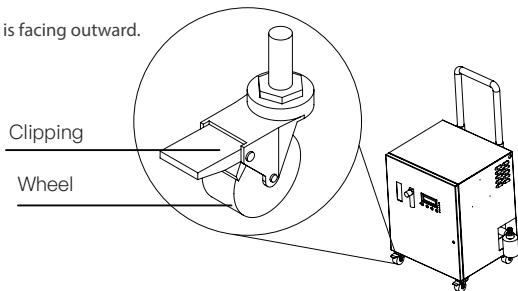

2. To lock the castor wheel, the clipping must be pressed downwards.

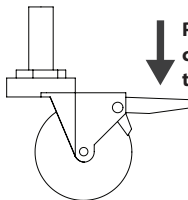

**Pressed  
clipping down  
to lock**

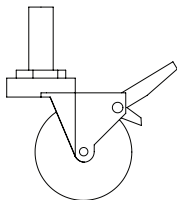

**Pulled clipping  
up to unlock**

3. To unlock the castor wheel, the clipping must be pulled upwards.
4. Do it for both wheels to lock/unlock it into position.

## Installation of device

### A. Mounting the device (Wall)

1. Mount a pair of wall plugs with M3 screws to the wall.

NOTE: Leave a distance of 1.5 cm screw length from the wall. Do not screw all the way in. The length allows the device to be hooked on safely.

2. Hook the Medklinn O3 Hydro 10 / 20 mounting slots onto the screws.

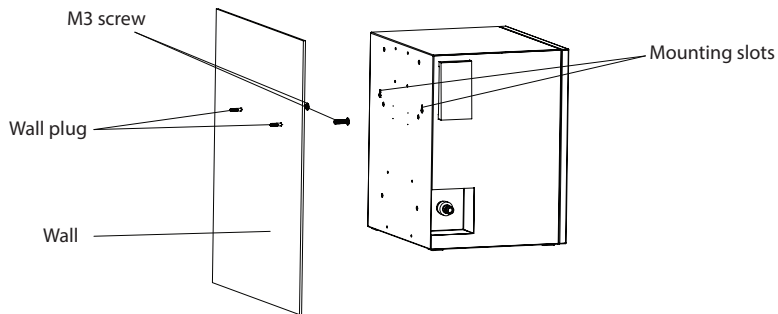

*For more information, please log on to [www.medklinn.com](http://www.medklinn.com)*

